

# Graduate Guidelines

Department of  
Electrical and Computer Engineering

# Graduate Guidelines

## Department of Electrical and Computer Engineering

University of Florida  
P. O. Box 116200  
Gainesville, FL 32611

Revised Fall 2018

Department Administration:

**John Harris**  
Department Chair

**Robert M. Fox**  
Associate Chair for Academics

**John M. Shea**  
Graduate Coordinator  
439 NEB  
(352) 505-0740  
Email: [jshea@ece.ufl.edu](mailto:jshea@ece.ufl.edu)

For Information:

**Graduate Advisor**  
Student Services Office  
230 Larsen Hall  
P.O. Box 116200  
University of Florida  
Gainesville, FL 32611  
(352) 392-9758  
Email: [gradadvising@ece.ufl.edu](mailto:gradadvising@ece.ufl.edu)

# Table of Contents

I.	Graduate Faculty and Research Areas .....	5
1.	Computer Engineering .....	5
2.	Devices.....	7
3.	Electromagnetics and Electric Energy Systems.....	8
4.	Electronics.....	9
5.	Signals & Systems .....	11
II.	Introduction.....	13
1.	General Degree Requirements .....	13
2.	Articulation Requirements .....	15
III.	Master's Degree - Thesis Option .....	16
1.	Course Requirements .....	16
2.	Appointment of Supervisory Committee .....	17
3.	Submission of Master's Thesis .....	17
4.	Final Examination Procedures .....	17
5.	Checklist for Thesis Option .....	18
IV.	Master's Degree - Non-thesis Option .....	19
1.	Course Requirements .....	19
2.	Final Examination Procedures - <i>Master of Science only</i> .....	20
3.	Checklist for Non-thesis Option .....	21
V.	Doctor of Philosophy Degree.....	22
1.	Course Requirements and Period of Concentrated Study.....	25
2.	Ph.D. Faculty Advisor.....	26
3.	Individual Development Plan.....	26
4.	Appointment of Supervisory Committee .....	26
5.	Leave of Absence Policy .....	26
6.	Official Minor .....	27
7.	Written Qualifying Exam.....	27
8.	Oral Qualifying Exam.....	28
9.	Status Meeting with Supervisory Committee .....	29
10.	Final Examination and Submission of Dissertation.....	29
11.	Checklist for Ph.D. Degree .....	31
VI.	Certificates .....	33
1.	Microsystem Technology Certification Program.....	33
2.	Hardware and Systems Security Certificate.....	33
VII.	Administrative Procedures.....	35
1.	Graduate Bulletin Boards.....	35
2.	Degree Audits .....	35
3.	Gatorlink Email Accounts.....	35
4.	Registration .....	35
5.	Add/Drop Policy .....	36
6.	GPA and Probation Policies.....	36
7.	Transfer of Credits .....	37
8.	Internship Policy .....	37
9.	Financial Aid.....	38
10.	Tuition Waivers .....	39

11.	No Assistantships While on Internship.....	39
12.	Readmission Procedures .....	39
VIII.	Format of Ph.D. Oral Qualifying Exam Proposal.....	40
X.	Graduate Course Descriptions .....	41
XI.	Graduate Research Division Flow Charts.....	42
	a. Computer Engineering .....	43
	b. Devices.....	44
	c. Electromagnetics & Energy Systems.....	45
	d. Electronics.....	46
	e. Signals & Systems .....	47

# I. Graduate Faculty and Research Areas

## 1. Computer Engineering

### **Daniela Oliveira – Area Chair**

This division focuses on theoretical and applied research by which next-generation computing and communications systems are designed, developed, and exploited. Research fields include high-performance computer architectures, computer networks, wireless networks, mobile computing, social networks and computing, privacy and security, parallel and distributed systems, reconfigurable systems, fault-tolerant computing, real time and embedded systems, and intelligent systems.

#### ***Swarup Bhunia***

Ph.D., Purdue University, 2005. Hardware security, design, test and validation for secure systems, adaptive nanocomputing, energy-efficient electronics, design of bioimplantable and wearable microsystems.

#### ***Yuguang (Michael) Fang***

Ph.D., Boston University, 1997. Wireless networks and mobile communications; personal communication services (PCS).

#### ***Renato Figueiredo***

Ph.D., Purdue University, 2001. Computer architecture, network computing, distributed systems.

#### ***Domenic Forte***

Ph.D., University of Maryland, 2013. Hardware security and trust, biometrics, reverse and anti-reverse engineering of electronics, nanoscale integration challenges, and digital VLSI/CAD.

#### ***Jose A. B. Fortes***

BellSouth Eminent Scholar Chair; Ph.D., University of Southern California, 1984. Network computing, advanced computing architecture, biologically inspired nanocomputing, distributed information processing systems.

#### ***Ann Gordon-Ross***

Ph.D., University of California- Riverside, 2007. Low-power design, reconfigurable computing, platform design, dynamic optimizations, hardware design, real-time systems, and multi-core platforms.

#### ***Yier Jin***

Ph.D., Yale University, 2012. Cybersecurity, IoT and CPS, hardware security, formal verification, microarchitecture.

#### ***Sanjeev Koppal***

Ph.D., Carnegie Mellon University, 2009. Computer Vision, Computational Photography, Sensors, Optics, Image/Video Processing.

***Herman Lam***

Ph.D., University of Florida, 1979. Computer engineering, database management and computer architecture.

***Haniph A. Latchman***

Ph.D., Oxford University, 1986. Mathematical systems theory, control systems, communication theory, data communication networks, multimedia information systems.

***Tao Li***

Ph.D., University of Texas at Austin, 2004. Computer and digital system architecture; interaction of computer architecture, emerging applications, operating systems, programming language features, managed run-time environments; modeling, simulation and evaluation of computer systems.

***Xiaolin (Andy) Li***

Ph.D., Rutgers University, 2005. Parallel and Distributed Systems (PDS) and Cyber-Physical Systems (CPS), focusing on design of scalable algorithms and software systems to enable large-scale applications.

***Janise McNair***

Ph.D., Georgia Institute of Technology, 2000. Wireless and mobile networking, next generation wireless systems, medium access control protocols.

***Sean Meyn***

Pittman Eminent Scholar Chair; Ph.D., McGill University, 1987. Markov processes (with or without control), spectral theory and large deviations; Stochastic approximation, reinforcement learning and simulation; Detection and inference; Networked systems: control, visualization, and performance; Economics with applications to energy markets.

***Kamran Mohseni***

W.P. Bushnell Endowed Professor; Ph.D., California Institute of Technology, 2000. Aerial and underwater vehicle control, autonomous systems, cooperative control, mobile wireless sensor networks, and microfluidic devices.

***Daniela Oliveira***

Ph.D., University of California- Davis, 2010. Cross-layered and human-centric computer security, operating systems and software vulnerability analysis.

***Sandip Ray***

Ph.D., University of Texas at Austin; 2005. Trustworthy computing; security architecture, synthesis and validation; hardware/firmware/software codesign; design-for-resilience techniques for hardware/software systems; and post-silicon readiness and validation streamlining for System-on-Chip designs.

***Greg Stitt***

Ph.D., University of California- Riverside, 2007. Embedded systems with an emphasis in synthesis, compilers, reconfigurable computing, hardware/software co-design, low power-design, system-on-chip multi-core architectures, real-time systems, and run-time optimizations.

***Mark M. Tehranipoor***

Ph.D., University of Texas at Dallas, 2004. Hardware security and trust, supply chain security, and reliable and testable circuit design at nanoscale.

**Dapeng Wu**

Ph.D., Carnegie Mellon University, 2003. Wireless communications, video coding, multimedia communication, computer and communication networks, information and network security, pervasive and mobile computing, information and communication theory, signal processing, detection and estimation theory.

**Tuba Yavuz**

Ph.D., University of California- Santa Barbara, 2004. Automated verification and analysis, model checking, and automated model extraction.

## 2. Devices

### Jing Guo – Area Chair

The device division focuses on the behavior, fabrication, and design of devices. These include optoelectronics (solar cells and detectors), transistors (SiGe, MIS, III-V), MEM's (mechanical, optical, biological sensors), and nanodevice concepts (CNT, Graphene, Molecular, Silicon-based). There is research on both how materials interact with voltage, current, photons, and radiation as well as the current-voltage relationship of device structures.

**David P. Arnold**

Ph.D., Georgia Institute of Technology, 2004. Design, fabrication, and characterization of magnetic and electromechanical microsensors/microactuators, as well as miniaturized power and energy systems.

**Navid Asadi Zanjani**

Ph.D., University of Connecticut, 2014. Devices, electronics, hardware security, reverse engineering, 3D imaging and image processing, failure analysis and sensors.

**Jerry G. Fossum (Emeritus)**

Ph.D., University of Arizona, 1971. Semiconductor device theory, modeling, and simulation; nanoelectronics, integrated circuits (ICs), IC technology computer-aided design (TCAD); silicon-on-insulator (SOI) and double-gate (DG) CMOS ICs.

**Jing Guo**

Ph.D., Purdue University, 2004. Modeling and simulation of nanoelectronic devices, carbon nano electronics and photonics, physics of nanotransistors, computational nanobiotechnology.

**Jack Judy**

Intel/Charles E. Young Endowed Chair in Nanotechnology; Ph.D., University of California Berkeley, 1996. Neuroengineering, Micromachining and MEMS technologies, including microsensors, microactuators, microsystems, and their biomedical applications.

**Mark E. Law**

Associate Dean of Academic Affairs, Ph.D., Stanford University, 1988. Design and modeling of IC fabrication process, computer modeling of semiconductor process and device behavior, numerical solution of partial differential equations.

**Arnost Neugroschel (Emeritus)**

Ph.D., Technion, Israel Institute of Technology, 1973. Semiconductor device physics, device technology and characterization.

***Toshikazu Nishida***

Ph.D., University of Illinois-Urbana, 1988. Research and development of reliable, high performance, multi-functional semiconductor devices and solid-state physical sensors and actuators for microsystems employing strained Si, SiGe, GaN, ferroelectrics, and polymers. Applications include biomedical, energy harvesting, logic, and micro-electro-mechanical systems.

***Roozbeh Tabrizian***

Ph.D., Georgia Institute of Technology, 2013. Theoretical and experimental investigation of mixed-domain micro- and nano-physical devices; micromechanical resonators and resonant-based sensors; phonon engineering; as well as development of micro- and nano-fabrication techniques for large-scale integration of microsystems.

***Scott Thompson***

Ph.D., University of Florida, 1992. Solid state electronics and nano technology, new materials and devices to extend Moore's law. Electrical measurements and modeling of strained Si, Ge, GaN semiconductors.

***Ant Ural***

Ph.D., Stanford University, 2001. Carbon nanotubes, semiconductor nanowires, and related nanostructures. Integration of nanotechnology with silicon microfabrication processes. Molecular electronics, nanoscale MEMS, and nanobiotechnology.

***Huikai Xie***

Ph.D., Carnegie Mellon University, 2002. Semiconductor devices, integrated microsensors and microactuators, optical MEMS, biosensors, biomedical imaging, fiber optics, micro/nano fabrication technology, and multi-domain simulation.

***Yong-Kyu (YK) Yoon***

Ph.D., Georgia Institute of Technology, 2004. 3-D MEMS technology; micromachined metamaterials for radio frequency and microwave applications; millimeter-wave antennas and waveguides; lab-on-a-chip type bio/microfluidic systems; anodized nanoporous membranes and electrospun nanofibers for its bio/optical applications; microsensors and actuators; electronic and MEMS packaging; and ferroelectric materials and their RF applications.

***Peter Zory (Emeritus)***

Ph.D., Carnegie-Mellon University, 1964. Semiconductor lasers physics and technology.

### 3. Electromagnetics and Electric Energy Systems

#### Henry Zmuda – Area Chair

This division spans a wide area of research of electromagnetic fields and their application. It includes electromagnetic interaction with matter, guided wave devices, fiber optic communications, and photonic devices and systems. UF is one of the few universities in the world conducting lightning research. Experiments on lightning physics and lightning protection are performed each summer both on the UF campus and at Camp Blanding, Florida.

***David P. Arnold***

Ph.D., Georgia Institute of Technology, 2004. Design, fabrication, and characterization of magnetic



and electromechanical microsensors/microactuators, as well as miniaturized power and energy systems.

***Arturo Bretas***

Ph.D., Virginia Tech, 2001. Power Systems Protection, Analysis and Restoration; Distribution Systems Engineering; Distributed and Renewable Generation Insertion Impact on Electric Power Systems; Power Quality; Power Systems Transients; Distribution Systems Reliability; Power Systems State Estimation; Smart Grids

***Jenshan Lin***

Ph.D., University of California- Los Angeles, 1994. Microwave/millimeter-wave electronics and wireless communication circuits, high speed electronics and broadband communication circuits.

***Robert Moore***

Ph.D., Stanford University, 2006. Electromagnetic waves, non-linear energetic interactions in the ionosphere, remote-sensing applications of ELF/VLF wave propagation in the Earth-ionosphere waveguide.

***Vladimir A. Rakov***

Ph.D., Tomsk Polytechnic Institute, 1983. Lightning, atmospheric electricity, lightning protection.

***Ramakant Srivastava (Emeritus)***

Ph.D., Indiana University, 1973. Integrated optics and waveguide sensors.

***Martin A. Uman***

Ph.D., Princeton University, 1961. Lightning, atmospheric electricity, electromagnetics.

***Shuo Wang***

Ph.D., Virginia Tech, 2005. Power electronics, electrical power, electromagnetic interference, renewable energy conversion and integration with power grid, power grid support with power electronics, electrification of transportation.

***Henry Zmuda***

Undergraduate Coordinator, Ph.D., Cornell University, 1984. RF/Microwave photonic systems, optically controlled phased array antennas, phased array signal processing, photonic high speed analog-to-digital conversion.

***Peter Zory (Emeritus)***

Ph.D., Carnegie-Mellon University, 1964. Semiconductor lasers physics and technology.

## 4. Electronics

### Nima Maghari – Area Chair

This division covers a broad range of topics from the design and manufacturing of integrated circuits to their applications in real world systems. Current research includes mixed-signal electronics, data converters, biomedical circuits and systems, integrated power management, low power VLSI design, radio frequency and microwave circuits, IC test and validation, and modeling of materials, components, and circuits for high-frequency power electronics.

***Rizwan Bashirullah***

Ph.D., North Carolina State University, 2004. Circuit design techniques for high-performance analog/digital VLSI, electronic circuit devices and technology, high-speed signaling techniques and circuits for biomedical applications.

***William R. Eisenstadt***

Ph.D., Stanford University, 1986. Microwave integrated circuits, IC packages, VLSI, high-frequency measurements, mixed-mode s-parameters.

***Domenic Forte***

Ph.D., University of Maryland, 2013. Hardware security and trust, biometrics, reverse and anti-reverse engineering of electronics, nanoscale integration challenges, and digital VLSI/CAD.

***Robert M. Fox***

Associate Chair, Ph.D., Auburn University, 1986. Analog electronic circuit design.

***John G. Harris***

Chair, Ph.D., California Institute of Technology, 1991. Analog and digital signal processing, VLSI, adaptive and neural systems.

***Mark E. Law***

Associate Dean of Academic Affairs, Ph.D., Stanford University, 1988. Design and modeling of IC fabrication process, computer modeling of semiconductor process and device behavior, numerical solution of partial differential equations.

***Jenshan Lin***

Ph.D., University of California-Los Angeles, 1994. Microwave/millimeter-wave electronics and wireless communication circuits, high speed electronics and broadband communication circuits.

***Nima Maghari***

Ph.D., Oregon State University, 2010. High performance data converters, delta-sigma modulators, synthesizable analog to digital converters, data converters for biomedical applications, time assisted conversion techniques.

***Scott Thompson***

Ph.D., University of Florida, 1992. Solid state electronics and nano technology, new materials and devices to extend Moore's law, Electrical measurements and modeling of strained Si, Ge, GaN semiconductors.

***Shuo Wang***

Ph.D., Virginia Tech, 2005. Power electronics, electrical power, electromagnetic interference, renewable energy conversion and integration with power grid, power grid support with power electronics, electrification of transportation.

***Yong-Kyu (YK) Yoon***

Ph.D., Georgia Institute of Technology, 2004. 3-D MEMS technology; micromachined metamaterials for radio frequency and microwave applications; millimeter-wave antennas and waveguides; lab-on-a-chip type bio/microfluidic systems; anodized nanoporous membranes and electrospun nanofibers for its bio/optical applications; microsensors and actuators; electronic and MEMS packaging; and ferroelectric materials and their RF applications.

## 5. Signals & Systems

### Tan Wong – Area Chair

Studies in this field are related to the transmission, creation, manipulation, and understanding of signals and systems. Signal processing looks to take data from a wide variety of sources (speech, audio, images, video, radar, sensor networks) and transforming it into useable pieces. Communication systems are designed to transmit information while minimizing the corruptive effects of noise and interference.

#### ***Zoleikha Biron***

Ph.D., Clemson University, 2017. Cyber physical systems, Dynamic systems and control, Estimation And fault diagnosis of dynamic systems, Control theory, Fault-tolerant control, Optimization, Multi-agent systems, Cooperative and connected vehicles, Intelligent transportation systems, Energy systems.

#### ***Jacob Hammer***

D. Sci., Technion, Israel Institute of Technology, 1980. Mathematical system theory, control systems.

#### ***Joel Harley***

Ph.D., Carnegie Mellon University, 2014. Signal Processing, data Science, machine learning, ultrasonics, structural health monitoring, smart infrastructure monitoring.

#### ***John G. Harris***

Chair, Ph.D., California Institute of Technology, 1991. Analog and digital signal processing, VLSI, adaptive and neural systems.

#### ***Sanjeev Koppal***

Ph.D., Carnegie Mellon University, 2009. Computer Vision, Computational Photography, Sensors, Optics, Image/Video Processing.

#### ***Haniph A. Latchman***

Ph.D., Oxford University, 1986. Mathematical systems theory, control systems, communication theory, data communication networks, multimedia information systems.

#### ***Jian Li***

Ph.D., Ohio State University, 1991. Signal processing for wireless communications and radar.

#### ***Sean Meyn***

Pittman Eminent Scholar Chair; Ph.D., McGill University, 1987. Markov processes (with or without control), spectral theory and large deviations; Stochastic approximation, reinforcement learning and simulation; Detection and inference; Networked systems: control, visualization, and performance; Economics with applications to energy markets.

#### ***Kamran Mohseni***

W.P. Bushnell Endowed Professor; Ph.D., California Institute of Technology, 2000. Aerial and underwater vehicle control, autonomous systems, cooperative control, mobile wireless sensor networks, and microfluidic devices.

#### ***Karim Oweiss***

Ph.D., University of Michigan- Ann Arbor, 2002. Statistical signal processing and information theory,

computational and systems neuroscience, neural engineering, brain-machine interfaces.

***Jose C. Principe***

BellSouth Chair; Ph.D., University of Florida, 1979. Adaptive non-Gaussian signal processing, nonlinear dynamical systems, information-theoretic learning, applications to pattern recognition and DSP systems, information technology in education.

***John M. Shea***

Ph.D., Clemson University, 1998. Wireless communications and networking, software-defined radio, and networked autonomous systems.

***Fred J. Taylor (Emeritus)***

Ph.D., University of Colorado, 1969. Digital signal processing, digital computer design and architecture.

***Tan F. Wong***

Ph.D., Purdue University, 1997. Wireless communications, spread spectrum systems, multiuser communications, adaptive signal processing.

***Damon L. Woodard***

Ph.D., University of Notre Dame, 2005. Biometrics, identity science, pattern recognition, machine learning, as well as image / signal analysis.

***Dapeng Wu***

Ph.D., Carnegie Mellon University, 2003. Wireless communications, video coding, multimedia communication, computer and communication networks, information and network security, pervasive and mobile computing, information and communication theory, signal processing, detection and estimation theory.

***Alina Zare Glenn***

Ph.D., University of Florida, 2008. Machine learning, image analysis, remote sensing, hyperspectral image analysis, sparsity promotion and pattern recognition.

## II. Introduction

The graduate program of the Department of Electrical and Computer Engineering at the University of Florida offers the Master of Engineering (M.E.), Master of Science (M.S.), and Doctor of Philosophy (Ph.D.) degrees. The ECE Graduate Guidelines (contained in this document) detail the departmental policies and regulations governing these degree programs and should be used in conjunction with the University of Florida *Graduate Catalog*. It is the responsibility of the student to be familiar with both publications and to adhere to the stated rules and policies.

More information regarding the Joint MS/MSM, Joint JD/MS, and other degree program options can be found on the web at <http://www.ece.ufl.edu/content/joint-degree-programs>.

### 1. General Degree Requirements

For the Master's degree, a minimum of 30 credit hours is required. The Ph.D. degree requires the accumulation of at least 90 credit hours beyond the bachelor's degree (excluding all credit hours from an Engineer's degree).

Master's students may transfer a maximum of 9 credits from an outside institution approved by UF. Doctoral students may transfer up to 30 credit hours from a Master's degree in electrical and computer engineering taken at an outside institution approved by UF.

The Master of Engineering (M.E.) degree is awarded only to students with a B.S. in engineering or to students who have completed appropriate articulation courses. The Master of Science (M.S.) degree is awarded to students with an undergraduate degree in any appropriate area of science or engineering.

All work counted for a Master's degree must be completed during the seven years immediately preceding the date on which the degree is to be awarded.

To graduate from any of the above-mentioned degree programs, a 3.00 is required in the overall (UF) and ECE-cumulative grade point averages.

An off-campus student who is a candidate for an electrical and computer engineering degree must take at least half the coursework from full-time University of Florida faculty members. Students can presently meet this requirement by attending lectures on the UF campus or using lectures distributed via distance learning.

No graduate credit is allowed for electrical and computer engineering courses below the 5000 level. Graduate students may take additional undergraduate courses, but credits earned in these courses are not counted toward the minimum degree requirements. A summary of the pertinent degree requirements is shown in the following table. For detailed requirements, see the appropriate sections that follow.

Req.	ME (The.)	ME (Non-the.)	MS (The.)	MS (Non-the.)	Ph.D.
Total hrs.	30	30	30	30	90 <sup>a</sup>
Min. ECE course credits	18 <sup>*h</sup>	21 <sup>*h</sup>	18 <sup>*h</sup>	21 <sup>*h</sup>	15 <sup>**h,k</sup>
Depth Req.	9 <sup>*hj</sup>	9 <sup>*hj</sup>	9 <sup>*hj</sup>	9 <sup>*hj</sup>	N/A
Breadth Req.	3 <sup>*hi</sup>	3 <sup>*hi</sup>	3 <sup>*hi</sup>	3 <sup>*hi</sup>	N/A
Minimum number of supervisory committee members	3	1	3	1	4 <sup>b</sup>
Qualifying Ex. Req'd.	no	no	no	no	yes <sup>c</sup>
Final Ex.	oral <sup>e</sup>	none	oral <sup>e</sup>	interview <sup>d</sup>	oral <sup>f</sup>
Time limit for completing degree	7 yrs	7 yrs	7 yrs	7 yrs	5 yrs <sup>g</sup>

Footnotes:

\* Excludes: EEL 5905, 6065, 6905, 6910, 6933, 6940, 6971

\*\* Excludes: EEL 5905, 6065, 6905, 6910, 6933, 6940, 6971, 7940, 7979, 7980

a May include 30 hours from Master's program

b Includes one member outside the ECE department

c Written part within the first year of entry

d Mock Job Interview

e On thesis and coursework

f On dissertation

g Five years from admission to candidacy

h UF ECE courses only, CDA 5636 approved by exception

i Credit hours must be in a research division outside of depth research division

j At least three credits must be at the 6000 level

k At least 50% of credits used for the Ph.D. degree must be from ECE at UF

## 2. Articulation Requirements

Students entering the graduate ECE program from a non-ECE background are welcome in the department.

All students must have completed coursework in at least three of the eight topic areas cited in the Ph.D. qualifying exam, which currently include:

- Digital Logic
- Signals and Systems
- Electronic Circuits
- Solid-State Devices
- Electromagnetism and Energy Systems
- Microprocessor Applications
- Computer Organization and Architecture
- Data Structures and Operating Systems

These requirements may be satisfied, with a grade of B or higher, as follows:

- Previous undergraduate coursework (e.g. physics course in electromagnetics, computer science courses in data structures and operating systems);
- Enrollment in and successful completion of appropriate UF undergraduate courses; or,
- Pass the Ph.D. written qualifying exam.

Additional courses may be required to fulfill necessary background material needed to successfully complete graduate-level course requirements. Many graduate-level ECE courses have implicit undergraduate course prerequisites. Students are expected to have mastered the undergraduate skills necessary to provide appropriate foundation for graduate courses they attempt.

All articulation requirements must be satisfied within the first 12 months of beginning graduate studies.

### III. Master's Degree - Thesis Option

The Department of Electrical and Computer Engineering offers the thesis option for the Master of Engineering and Master of Science degrees. A student seeking a Master's degree with a thesis option is required to pass an oral final examination.

#### 1. Course Requirements

For the thesis option of a Master's degree, students must complete at least 30 credit hours, which include a maximum of six credit hours of EEL 6971 (Research for Master's Thesis). Thesis students must be registered for three credit hours of thesis (EEL 6971) in the term of graduation (Fall and Spring, and two credits in summer). EEL 6065, EEL 6910, EEL 6933, and EEL 6940 cannot be used to fulfill any credit requirements for the Master's degree. The course requirements include a minimum of 18 hours of Electrical and Computer Engineering courses, excluding EEL 5905, 6905, and EGN 5949. CDA 5636 (Embedded Systems) can be used toward this course requirement by exception. This course requirement can only be fulfilled by completing ECE coursework at the University of Florida.

Students are required to complete a 12 credit hour depth/breadth requirement in order to receive a Master's degree in ECE. To complete this depth/breadth requirement, students must take at least 9 depth credits of ECE coursework from one of the five research divisions housed in the ECE department (i.e., Computer Engineering, Devices, Electromagnetics and Energy Systems, Electronics, Signals & Systems). At least three of these nine depth credits must be at the 6000 level. In addition, students must complete at least three breadth credits of coursework in the ECE department outside of their declared depth research division. Students can determine which ECE courses are housed in each research division by referring to the research division flow charts at the end of this manual. ECE courses used to complete this depth/breadth requirement will be counted toward the minimum 18 credits of ECE coursework required for the Master's thesis degree.

Up to 18 hours of Special Topics (EEL 5934, 6935, and 7936) may be applied toward the degree. Up to six hours of unstructured credit hours total (EEL 5905, EEL 6905 or EGN 5949) may be applied toward the degree. Students can count a maximum of 3 credits of EGN 5949 toward their degree program.

Students must receive a final grade of "C" or better to receive degree credit for a letter graded course. A course with a final grade of "C" and above cannot be repeated for credit. If a student receives a grade less than a "C" for a course, s/he may retake the course and an average of both grades will be used when compiling GPA graduation requirements. Courses in which students receive a grade of "C-" or lower will not be used to fulfill credit requirements but will adversely affect a student's GPA.



## 2. Appointment of Supervisory Committee

The supervisory committee is the group of faculty members that supervises and approves the student's graduate program. The committee's function is to guide the student through his/her thesis research and to administer the oral final examination.

The supervisory committee should be selected as soon as possible but no later than the end of the second semester. After the committee has been determined, the student should obtain a Supervisory Committee Form from the ECE Student Services Office (230 Larsen) and have the professors sign the form indicating their willingness to serve on the committee. The Graduate School may deny degrees to any persons who have failed to comply with this regulation at the proper time.

The committee for the Master's degree, thesis option, must consist of at least three graduate faculty members. The chairperson and at least one member must be a graduate faculty member in Electrical and Computer Engineering department. The chairperson is usually the student's academic advisor and should advise the student in the selection of the other committee members.

## 3. Submission of Master's Thesis

Students must submit their thesis electronically. Students should refer to the Graduate School Editorial Office for more information regarding their thesis submission.  
(<http://gradschool.rgp.ufl.edu/editorial/introduction.html>)

Electronic submission requires a signed ETD Submission Approval Form (submitted directly by student). A hardcopy of Final Exam form and Signature Page must be submitted to the Student Services Office, 230 Larsen.

## 4. Final Examination Procedures

Up to six months prior to graduation, the supervisory committee will give the student an oral examination on the thesis, on major and minor subjects, and on matters pertaining to any specific field of study.

Each student is responsible for applying for his/her degree by the published deadlines for the semester of graduation. The degree application is available online via ONE UF ([HTTP://ONE.UF.EDU](http://ONE.UF.EDU)). Students are also required to meet with the Graduate Advisor in the Student Services Office at the beginning of the semester that they intend to graduate to ensure that all degree requirements have been met. If a student fails to apply by the specified deadline, s/he will not receive the degree that semester.

It is imperative that copies of the student's thesis be given to the supervisory committee at least two weeks in advance of the final examination. Graduation may be delayed for those who do not adhere to this rule. The Student Services Office should be informed of the examination one week prior to the thesis defense date in order to process the Final Exam Report form and send out notices.

Students are also required to complete an Exit Survey during the semester they plan to graduate. Students can find more information about the Exit Survey in the Student Services Office.

## 5. Checklist for Thesis Option

	To Do	When
	If appropriate, transfer up to 9 credit hours from graduate courses taken previously to your UF master's program.	First semester
	Appoint supervisory committee. This committee must be appointed by the end of the second semester	Second semester
	Check with the Student Services Office to see if all graduation requirements, including appropriate course hour credit, will be satisfied.	Semester before graduation
	If you have any grades less than C (i.e. C-, D, I, or E grades), discuss your options for meeting graduation requirements.	
	Submit degree application online via ONE.UF ( <a href="http://one.uf.edu">http://one.uf.edu</a> ). Complete graduation check in Student Services Office.	Semester of graduation
	Comply with Graduate School thesis and final examination deadline dates.	
	Be registered for at least the minimum number of thesis hours (3 hours in the fall and spring semester, 2 hours in the summer)	
	Schedule the Thesis Defense with the supervisory committee. Inform the Student Services Office of plans to take the examination, and reserve a conference room. The Student Services Office will send the announcement of exam and prepare the Final Exam Report.	
	At least two weeks in advance of the final examination, give the supervisory committee members a copy of the thesis.	
	On the day of the examination, report to the Student Services Office to pick up the necessary forms.	
	Have the Final Examination Report form and the original signature page of the thesis signed by the supervisory committee members. Return the Final Examination Report form to the Student Services Office.	
	Submit the final thesis, as required, to the Graduate School Editorial Office.	
	Complete the Exit Survey.	

## IV. Master's Degree - Non-thesis Option

The Department of Electrical and Computer Engineering offers the non-thesis option for the Master of Engineering and Master of Science degrees. The non-thesis Master of Science student is required to do a technical job interview with an assigned faculty member. No final exam is required for students pursuing the non-thesis Master of Engineering degree.

### 1. Course Requirements

For the non-thesis Master's degree option, students must complete 30 graduate level credit hours. EEL 6065, EEL 6910, EEL 6933, and EEL 6940 cannot be used to fulfill any credit requirements for the Master's degree. At least 21 hours of ECE coursework must be taken. This course requirement can only be fulfilled by completing ECE coursework at the University of Florida. EEL 5905, 6905, and EGN 5949 are not counted for this requirement. CDA 5636 (Embedded Systems) can be used toward this course requirement by exception. No credit for EEL 6971 is allowed.

Students are required to complete a 12 credit hour depth/breadth requirement in order to receive a Master's degree in ECE. To complete this depth/breadth requirement, students must take at least 9 depth credits of ECE coursework from one of the five research divisions in the ECE department (i.e., Computer Engineering, Devices, Electromagnetics and Energy Systems, Electronics, Signals & Systems). At least three of these nine depth credits must be at the 6000 level. In addition, students must complete at least three breadth credits of coursework in the ECE department outside of their declared depth research division. Students can determine which ECE courses are housed in each research division by referring to the research division flow charts at the end of this manual. ECE courses used to complete this depth/breadth requirement will be counted toward the minimum 21 credits of ECE coursework required for the Master's non-thesis degree.

Master of Science non-thesis students must successfully complete a technical job interview with an ECE faculty member (see section below). Master of Engineering non-thesis students do not have to complete a final written examination.

Up to 18 hours of Special Topics (EEL 5934, 6935, and 7936) may be applied toward the degree. Up to six hours of unstructured credit hours total (EEL 5905, EEL 6905 or EGN 5949) may be applied toward the degree. Students can count a maximum of 3 credits of EGN 5949 toward their degree program. No other S/U credit can be counted toward the degree.

All non-thesis students are required to have a one-member supervisory committee. The ECE department chair serves as the default non-thesis committee member for all non-thesis students and is automatically appointed for all non-thesis students during their graduating semester.

Students must receive a final grade of "C" or better to receive degree credit for a letter graded course. A course with a final grade of "C" and above cannot be repeated for credit. If a student receives a grade less than a "C" for a course, s/he may retake the course and an average of both grades will be used when

compiling GPA graduation requirements. Courses in which students receive a grade of “C-“ or lower will not be used to fulfill credit requirements but will adversely affect a students’ GPA.

## 2. Final Examination Procedures - *Master of Science only*

The MS non-thesis final exam will be administered each semester and students will complete their mock job interview during their second semester of enrollment. Students will register for their mock job interview via a registration web form and will select a preferred research division from which a faculty member will be assigned to conduct the interview. After the registration period closes, the student will receive a faculty assignment from the ECE Graduate Advisor. Each student will be responsible for emailing their assigned faculty member to set-up a mock job interview. Interviews will need to be completed before the stated deadline for the semester.

Students will be required to submit a one-page job application cover letter and resume to their assigned faculty member 24 hours in advance of their appointment via email. Students are required to dress appropriately for the “job interview”. Students may contact the Career Connections Center for more information regarding appropriate cover letter and resume formats. The Career Connections Center can also provide students with information regarding appropriate dress for a job interview.

The faculty member will ask questions as deemed appropriate and students will be assigned a pass/fail grade. If a student has deficiencies that result in a failing grade, he/she can schedule another interview with the same faculty member to address those issues. Students are required to submit a signed MS non-thesis final exam form to the Student Services Office (Larsen 230) by the stated deadline. Failure to submit this form by the deadline may result in delayed graduation.

Students are also be required to complete an Exit Survey during the semester in which they intend to graduate to complete the MS non-thesis final exam requirement.

### 3. Checklist for Non-thesis Option

	<b>To Do</b>	<b>When</b>
	If appropriate, transfer up to 9 credit hours from graduate courses taken previously to your UF master's program.	First semester
	Sign-up for a mock job interview. By the registration deadline, register for the mock job interview online via the current graduate student web page of the departmental web site and indicate your selected area.	Second Semester
	Check with the Student Services Office to see if all graduation requirements, including appropriate course hour credit, will be satisfied.	Semester before graduation
	If you have any grades less than C (i.e. C-, D, I, or E grades), discuss your options for meeting graduation requirements.	
	Submit degree application online via ONE.UF ( <a href="http://one.uf.edu">http://one.uf.edu</a> ). Complete graduation check in Student Services Office.	Semester of graduation
	Complete the Exit Survey.	

## V. Doctor of Philosophy Degree

### 1. Course Requirements and Period of Concentrated Study

For the Ph.D. degree, at least 90 credit hours beyond the bachelor's degree are required. These hours include master's degree work taken at the University of Florida or, if appropriate, up to 30 hours of master's degree work in ECE earned at another approved university outside UF. The hours accumulated for the Ph.D. degree have the following restrictions:

- Ph.D. Coursework Requirement- At least 24 hours of 5000, 6000, or 7000 level College of Engineering (COE), Math, Statistics, and/or Physics letter graded courses are required. Of these 24 coursework hours, at least 15 credits of graduate level letter graded coursework hours must be taken in the ECE department. CDA 5636 (Embedded Systems) can be used toward this 15 credit ECE coursework requirement by exception. Students must receive a grade of "B" or better in the 24 credit hour courses. These 24 coursework credit hours must be approved by the student's faculty advisor and supervisory committee. Students will need to work in conjunction with their faculty advisor and supervisory committee to determine which courses will be most relevant to their research topic. Individual work/independent study hours (i.e. EEL 5/6905), EEL 6065, EEL 6933, and EEL 6940 cannot be used to fulfill this 24 coursework credit hour requirement. ECE courses taken in a master's program at UF are automatically included. This course requirement can only be fulfilled by completing ECE coursework at the University of Florida. This coursework requirement must be completed before the status meeting with the student's supervisory committee (one year before graduation).
- Seminar Requirement- Two semesters of EEL 6933 are required.
- Supervised Teaching Requirement- Two semesters of EEL6940 are required. This requirement exposes Ph.D. students to the rigors of teaching in a higher education setting. Students will be paired with a faculty member and will help manage, teach, grade, interact with students outside of class and, if appropriate, will give a lecture in the course.
- Up to 18 hours of Special Topics (EEL 5934, 6935, and 7936) may be applied toward the degree. Up to six hours of unstructured credit hours total (EEL 5905, EEL 6905 or EGN 5949) may be applied toward the degree. Students can count a maximum of 3 credits of EGN 5949 toward their degree program.
- All EEL 7980 (Research for Doctoral Dissertation) credit hours are counted. Students cannot register for EEL 7980 hours until they have been officially admitted to candidacy (passed written and oral qualifying exam). Students must be admitted to candidacy for a minimum of two semesters before graduation. Students can count the semester that they are admitted to candidacy if they complete their oral qualifying exam by the midpoint deadline of a semester. The midpoint of the term is determined by the Graduate School and is published in its "Deadline Dates".
- Fifty percent of all hours accumulated have to be in ECE at the 5000, 6000 or 7000 level (including EEL 7979 & 7980).
- Only 30 hours from a Master's degree not awarded by the ECE department at UF may be counted toward the Ph.D. degree (see Transfer of Credit section of Administrative Procedures for more information).



Candidates for the doctoral degree must satisfy the minimum requirements for a period of concentrated study, beyond the first 30 semester hours counted toward the doctoral program. Students must complete 30 credits enrolled at the University of Florida campus or the Graduate Engineering and Research Center (REEF). Courses at the 1000 or 2000 level will not be counted toward the concentrated study requirement.

## 2. Ph.D. Faculty Advisor

All Ph.D. students must identify a faculty advisor during their first year of study. A preliminary program of study signed by the faculty advisor must be submitted to the SSO no later than the mid-point of the first summer semester as a Ph.D. student. Ph.D. students are not permitted to register for doctoral research hours (EEL 7979, EEL 7980) until they have submitted their preliminary program of study signed by their faculty advisor.

## 3. Individual Development Plan

The Individual Development Plan (IDP) is a series of documents that each doctoral student at UF must complete with her or his faculty advisor each year. It is designed to identify students' professional and personal goals, highlight areas of weakness, and help students work with their advisors to create attainable steps for fulfilling long-term goals.

The IDP is housed in Canvas, the University of Florida's e-learning management system.

## 4. Appointment of Supervisory Committee

The supervisory committee is a group of faculty members who supervise and approve qualifications for the Ph.D. degree. The committee should be appointed as soon as possible, but no later than the midpoint of the second fall semester enrolled as a Ph.D. student. A hold may be placed on the student's record if they do not meet this requirement. The committee consists of four or more graduate faculty members with at least two of the members having Graduate Faculty status in the ECE department. The committee chairperson must have Graduate Faculty status and be from the ECE department or have an appointment in the ECE department.

One member of the committee must be from a discipline outside of the department and must maintain graduate faculty status in their respective department.

After the committee has been determined, in consultation with the faculty advisor, the student should obtain a Supervisory Committee Form from the Student Services Office (Larsen 230) and have the professors sign the form indicating that they are willing to serve on the committee.

## 5. Leave of Absence Policy

A doctoral student who will not be registered at UF for a period of more than one semester needs to request written permission from his/her faculty advisor for a leave of absence for a designated period of time. A copy of the written permission memo must be taken to the Student Services Office and placed in the student's file.



## 6. Official Minor

With the approval of the supervisory committee, a student may choose one official minor field (minimum 12 graduate credit hours). Official minor coursework cannot be counted toward the 24 hour ECE coursework requirement.

Minor work may be completed in any department, other than ECE, that is approved for master's or doctoral degree programs as listed in the *University of Florida Graduate Catalog* and supports a program that is related to the student's Ph.D. research area.

If an official minor is chosen, the supervisory committee must include a representative from the minor field.

If an official minor is chosen, a representative of the minor department, who may or may not be on the supervisory committee, shall designate at least one 6-hour graduate course sequence in the minor field for written qualifying examination. It is the student's responsibility to schedule the exam with the professor in the minor department. The student must pass this exam in order for the minor to be valid. The official minor exam must be completed before the student can be admitted to candidacy.

## 7. Written Qualifying Exam

The Ph.D. written qualifying exam is a test reviewing fundamental material that students are expected to have covered before joining the doctoral program. The questions are taken from the following areas of ECE:

- Digital Logic
- Signals and Systems
- Electronic Circuits
- Solid State Devices
- Electromagnetism and Energy Systems
- Microprocessor Applications
- Computer Organization and Architecture
- Data Structures and Operating Systems

Each student selects three areas before the examination and receives two questions in each one of the selected areas. Answers must be given to four of the six questions, including at least one question from each of the three areas. The examination tests problem solving skills, fundamental understanding, reasoning ability, and written communication skills. The test will last for two hours. No materials are allowed during the examination. The department will provide scientific calculators for use during the exam.

The written qualifying exam is offered only once a year in January on a Saturday shortly after the start of Spring classes. Students must sign up for their selected areas in the Student Services Office by the end of November in the preceding year. Detailed study guides will be available in the fall semester.

Students must take the written qualifying exam during their first year in the doctoral program. Financial support may be contingent on taking the exam. Upon failure, the written qualifying exam can be retaken the next time it is offered. If more than two attempts are required, students may petition the Graduate Petitions Committee for permission to retake the exam. A successful petition must include a letter of support from the

proposed Ph.D. advisor.

For students that transfer to UF with a faculty member hired from another university and that have already completed the qualifying exam at their previous university, the faculty member may petition for the student to take an alternative form of the qualifying exam based on the previous exam under certain conditions. The faculty member should contact the Graduate Coordinator for details.

Students with a minor in another department have to arrange for a written qualifying exam in their minor to satisfy the Graduate School requirements. The exam must be administered by the student's minor supervisor.

## 8. Oral Qualifying Exam

The Ph.D. oral qualifying exam (i.e. oral proposal) must be completed by the end of the second spring semester enrolled as a Ph.D. student. The oral qualifying exam consists of:

- Presenting his/her written research proposal
- Answering questions asked by the supervisory committee and others present

Format specifications for the oral proposal document can be found in Section VII of this document.

The Student Services Office must be notified at least one week in advance of the oral qualifying examination so the Announcement of Examination form can be mailed and the Admission to Candidacy form prepared. This form should be taken to the qualifying exam by the student, signed by the supervisory committee and returned to the Student Services Office for processing.

If the student fails the oral portion of the qualifying exam, s/he may retake it only once and it must be retaken within two semesters.

If a student fails the oral qualifying exam for a second time, the Graduate School will be notified. A re-examination may be requested but it must be recommended by the student's supervisory committee and approved by the Graduate School. At least one semester of additional preparation is considered essential before re-examination.

Between the date of completion of the qualifying exam and the date of the degree, there must be a minimum of two semesters if the candidate is in full-time residence or a calendar year if the candidate is in attendance on less than a full-time basis. The semester in which the qualifying examination is completed is counted provided that the exam is completed before the midpoint of the term. No more than five years may pass between the completion of the qualifying exam and the conferring of the degree.

The doctoral student becomes a doctoral candidate when the following requirements are satisfied:

- The student academic record is satisfactory.
- Half (12 credits) of the Ph.D. coursework credit hour requirement is complete.
- The Supervisory Committee certifies that the student has made satisfactory progress to be admitted to candidacy.
- The student has a dissertation topic approved by his/her supervisory committee.

- The student has passed both the written (including the official minor exam if applicable) and oral portions of the qualifying exam.
- The Admission to Candidacy form has the required formal approvals.

## 9. Status Meeting with Supervisory Committee

A status meeting with the student's supervisory committee must be held at least two semesters before graduation and no sooner than the second semester after the oral proposal. Students will present their current progress on their dissertation to their supervisory committee. The supervisory committee will review the procedure, progress, and expected results of the dissertation topic and may make suggestions for completion of the dissertation. Students are expected to have completed their 24 credit Ph.D. coursework requirement as well as half of their dissertation before the status meeting can be scheduled.

The Student Services Office must be notified at least one week in advance of the meeting so the appropriate paper work can be prepared. This paper work should be taken to the status meeting by the student, signed by the supervisory committee and returned to the Student Services Office for processing.

A draft of the dissertation, formatted according to the Graduate School Editorial Office's specifications, will need to be provided to committee members at least two weeks in advance of the status meeting. Formatting requirements and technical assistance are available at the Academic Technology Office (<https://asc.helpdesk.ufl.edu/etd.html>).

## 10. Final Examination and Submission of Dissertation

The Ph.D. final exam consists of an oral defense of the research results that are described in the doctoral dissertation. This exam is given within six months of graduation, after the first submission of the dissertation, and the completion of all other prescribed work for the degree.

Students must submit the dissertation electronically. Students should refer to the Graduate School Editorial Office for more information regarding their dissertation submission. The guidelines are also online (<http://gradschool.rgp.ufl.edu/editorial/introduction.html>).

Electronic submission requires a signed ETD Submission Approval Form (submitted directly by student), Final Exam Form and Signature Page to the Student Services Office.

The Student Services Office should be informed of the examination one week prior to the defense date in order to process the Final Exam Report form and send out notices.

Copies of the student's dissertation must be given to the supervisory committee members at least two weeks in advance of the final examination. Graduation may be delayed for those who do not adhere to this rule.

At the time of the defense, all committee members should sign the signature pages in the dissertation and

sign the Final Exam Report form which is to be returned to the Student Services Office.

Students are also required to complete an Exit Survey during the semester they plan to graduate. Students can find more information about the Exit Survey in the Student Services Office.

All work for the Ph.D. degree must be completed within five calendar years after the completion of the Ph.D. qualifying exam.

## 11. Checklist for Ph.D. Degree

	To Do	When
	If appropriate, transfer graduate coursework to doctoral degree.	First Year
	Take the written portion of the qualifying exam.	
	Identify faculty advisor and turn in preliminary program of study by the midpoint of the first summer semester.	
	Appoint supervisory committee. The committee must be appointed no later than the midpoint of the second fall semester.	Second Year
	Arrange with the supervisory committee the details of your written research proposal that is to be presented in the oral exam.	
	Complete oral qualifying exam by the last day of the second spring semester.	
	At least one week in advance of the oral exam, notify, in writing, the Student Services Office of plans to complete the qualifying exam.	
	Complete the 24 credit hour Ph.D. coursework requirement.	One Year Before Graduation
	Seminar	
	Two semesters of Supervised Teaching	
	Arrange with the supervisory committee the details of your status meeting (two semesters prior to graduation). Provide supervisory committee with dissertation draft two weeks prior to the status meeting.	
	At least one week in advance of the status meeting, notify, in writing, the Student Services Office of plans to complete the status meeting	
	Check with the Student Services Office to see if all graduation requirements, including appropriate course hour credit, will be satisfied.	Semester before graduation
	If you have any grades less than C (i.e. C-, D, I, or E grades), discuss your options from meeting graduation requirements.	
	Submit degree application online via ONE.UF ( <a href="http://one.uf.edu">http://one.uf.edu</a> ). Complete graduation check in Student Services Office.	Semester of graduation
	Comply with Graduate School dissertation and final examination deadline dates.	
	Be registered for at least the minimum number of dissertation hours (3 hours in the fall and spring semester, 2 hours in the summer)	

**Checklist for Ph.D. Degree – *Continued***

	<b>To Do</b>	<b>When</b>
	Schedule the doctoral defense with the supervisory committee. Inform the Student Services Office of plans to take the examination one week prior to the exam and reserve a conference room. The Student Services Office will send the announcement of exam and prepare the Final Exam Report.	Semester of graduation
	At least two weeks in advance of the final examination, give the supervisory committee members a copy of the dissertation	
	On the day of the examination, report to the Student Services Office to pick up the necessary forms.	
	Have the original Final Examination Report form, Publishing Agreement (submit directly online), and ETD Signature Page of the dissertation signed by the supervisory committee members. Return these forms to the Student Services Office immediately after the dissertation defense for processing.	
	Submit an electronic copy to the Editorial Office of the Graduate School and the Student Services Office.	
	Complete the Exit Survey.	

## VI. Certificates

The ECE department offers students two certificate options. Interested students should contact Shannon Chillingworth ([ece-edge@ece.ufl.edu](mailto:ece-edge@ece.ufl.edu)) for more information.

### 1. Microsystem Technology Certification Program

The Microsystem Technology certificate prepares students for the complex, interdisciplinary development of microsystem technologies such as microactuators, microsensors, microfluidic devices, micropower systems, microoptical devices, and other microelectromechanical systems (MEMS). Students who successfully complete this certificate will receive a printed certificate from the UF Graduate School and a notation of completion on their transcript.

#### Requirements for Admission:

A bachelor's degree or equivalent from a regionally accredited institution. Students must be registered in a graduate degree program in the College of Engineering and maintain a 3.0 GPA.

Required Course Work	Certificate Course Work
EEE 5405	Microelectronic Fabrication Technologies
<b>Choose any two courses below:</b>	
EEE 5354L	Semiconductor Device Fabrication Laboratory
EEL 5225	Principles of Micro-Electro-Mechanical Transducers
EEE 6465	Design of MEMS Transducers
EEE 6460	Advanced Microsystem Technology
BME 5580	Microfluidics and BioMEMS

### 2. Hardware and Systems Security Certificate

The Hardware and Systems Security graduate certificate provides comprehensive training and education on all aspects of hardware security and its interaction with software and systems security. Courses provide a solid foundation of security issues and solutions related to electronic hardware.

#### Requirements for Admission:

Admission requires a bachelor's degree, in electrical and computer engineering (ECE) or similarly appropriate major (as defined by the ECE Dept.), from a regionally accredited institution. The program is open to currently enrolled UF graduate students and to non-degree-seeking students as well.

**Required Coursework:**

Required courses - (Total: 9 credits):

EEL 5855 Cross-Layered Systems Security (3 credits);

EEE 5716 Introduction to Hardware Security and Trust (3 credits);

EEL 6XXX Hands-On Hardware Security (3 credits);

Students must complete all three courses with a grade of B or better to earn the graduate certificate.



## VII. Administrative Procedures

### 1. Graduate Bulletin Boards/ECE Graduate Student Canvas Page

At least once a week, check the ECE Graduate bulletin boards, located outside 230 Larsen Hall, for announcements, changes in course offerings or room schedules, notices of examinations, and for other matters of interest to ECE graduate students. All ECE graduate students are members of the ECE Graduate Student Canvas page. Important notices and academic deadlines are posted to this page. All ECE graduate students are expected to monitor this Canvas page regularly. Please inform the ECE Graduate Advisor if you do not have access to this Canvas page.

### 2. Degree Audits

A student's degree audit is a condensed summary of their degree progress. Students can check their degree progress by viewing their degree audit online at ONE.UF (<http://one.uf.edu>). Students are expected to periodically review their degree audit to monitor their academic progress. Degree audits are a guidance tool and should be used in conjunction with advisement resources available in the Student Services Office.

### 3. Gatorlink Email Accounts

All ECE students are required to check their Gatorlink email accounts regularly. The Student Services Office and the University of Florida uses the Gatorlink accounts to deliver important announcements and deadline information to students. Failure to adhere to changes in policy and/or critical deadlines will result in delayed degree progress.

### 4. Registration

Students can register for classes online at ONE.UF (<http://one.uf.edu>). The Student Services Office is also available for help with registration and for registration to departmentally controlled courses.

Graduate students on appointment (TA, RA, GA) must register for the appropriate course load as indicated in the table below. Audited courses do not count as part of the hourly requirements for full time students or those on assistantships.

<b>Appointment</b>	<b>Minimum Credit Registration</b>	<b>Maximum Credit Registration</b>
Fellows and Trainees	12	18
1/4 Time Assistants	9	15
1/3 Time Assistants	9	15

1/2 Time Assistants	9	15
3/4 Time Assistants	6	9
Full-Time Assistants	3	3

Graduate students may not, in general, take any course under the S/U option except for certain graduate courses that have only S/U grading (as specified in the Graduate Catalog). Master's thesis and Ph.D. students who complete all graduate degree requirements during a given semester, but after the deadlines specified by the Graduate School, may receive their degree in the following semester without registering as clear prior students. Graduate School will determine a student's clear prior eligibility. Students whose degree requirements are not completed before the first day of classes of the following semester and all non-thesis Master's students must register for a minimum of three credit hours (two credits in the summer term) which will apply to the degree. ***The Graduate School will not accept petitions to this policy.***

## 5. Add/Drop Policy

Graduate students are allowed a limited number of schedule adjustments after the midpoint deadline of the semester\*. Students are permitted one schedule adjustment after the midpoint deadline per degree program. A schedule adjustment is defined as any of the following: adding a course, dropping a course, and/or switching coursework hours for another course (research hours, independent study, etc.). Student's requesting additional adjustments must petition the Graduate Coordinator for approval. A successful petition would require a letter of support from the student's faculty advisor.

**\*Students will be held fee liable for ANY course adjustments made after the stated university add/drop deadline.**

## 6. GPA and Probation Policies

In compliance with Graduate School rules, graduate students must maintain a GPA of 3.00 or higher in order to be in good standing. Students cannot graduate if their GPA is below 3.00.

Please note that the term "GPA" includes three different numbers, all of which need to satisfy the requirement of 3.00 or higher.

- The grade point average of ***all courses*** (3000 level and above) taken while classified as a graduate student;
- The grade point average of ***all ECE graduate level courses*** taken while classified as a graduate student;
- The grade point average of all graduate level courses that are part of a minor.

An academic hold will be placed on the records of all students whose GPA is below 3.00, thus placing the student on academic probation. These students will be able to register for courses only through the Student Services Office. This will enable our office to provide advice and guidance on an individualized basis.

Students on academic probation are not entitled to receive financial assistance in the form of Teaching Assistantships, Research Assistantships, or Fellowships.

Students with a GPA below 3.00 must show progress each semester towards improving their GPA, even if it takes more than one semester to reach a GPA of 3.00 or higher.

***Students who do not make sufficient academic progress as determined by the Graduate Coordinator will be dismissed from the program.***

## 7. Transfer of Credits

Master's and Ph.D. Students may apply to transfer graduate-level science and engineering coursework from another university or from non-degree seeking UF/EDGE coursework according to the policies below. Students may petition to transfer graduate level courses which were taken while classified as an undergraduate, postbaccalaureate, or non-degree seeking student, if proof is provided indicating that courses were not used to satisfy degree requirements for another degree. In all cases, only courses with a grade of "B" or better may be transferred. Credits obtained in non-degree programs, e.g. continuing education, may not be transferred. Credits transferred will be applied toward meeting the degree requirements, but the grades earned will not be computed in the student's grade point average unless the coursework was completed at UF. Credits for schools operating with more than two periods (e.g., trimesters) during the academic year will be scaled accordingly by the Graduate School; for example, 3 credits in a course that lasted one trimester will transfer as 2 credits by the Graduate School.

Application for transfer of credit earned after admission to a UF graduate program must be filed with the Graduate School as soon as possible but before the last day of classes preceding the term in which the degree is to be conferred. The student must provide a complete description of the graduate course in consideration for transfer and a transcript indicating the grade earned. The approval of the Graduate Coordinator and the Dean of the Graduate School are required for the acceptance of transfer credits.

### *Master's Students:*

Up to 9 credit hours of coursework may be transferred from an outside institution. Up to 15 credits of graduate-level non-degree seeking UF/EDGE coursework may be transferred. No more than 15 credits may be transferred into the student's Master's degree program.

### *Ph.D. Students:*

Students may transfer up to 30 credits of coursework from an outside institution into the student's Ph.D. degree program. Students with a Master's and additional Ph.D. coursework at another institution may petition the Graduate Coordinator to transfer up to 15 additional hours of coursework into the student's Ph.D. degree program. Up to 15 credits of graduate level non-degree seeking UF/EDGE coursework may be transferred. No more than 45 credits may be transferred into the student's Ph.D. degree program.

## 8. Internship Policy

ECE students can count up to three credits of EGN 5949 (Internship Work) toward their degree program.

In order to participate in the ECE Graduate Internship Program, students must have completed at least 18 UF ECE graduate level credits. Students must also have a minimum departmental and cumulative grade point average of 3.0. International students will also need to contact the International Center to verify their CPT eligibility. Internships are voluntary and are meant to compliment a student's degree program. Internships that impede a student's timely progress toward their degree will not be approved. Students who choose to complete an internship must be cognizant of the appropriate academic deadlines. **Internships CANNOT conflict with the start and end dates of the academic semester.**

Students who hold appointments at UF must be cognizant of the start and end dates of their appointments while making internship plans. Students are not permitted to be on appointment and be on internship at the same time. Students on appointment are responsible for knowing the start and end dates of their appointment when negotiating the timeframe of their internship. **Students who arrange internships that conflict with their UF appointment start and/or end dates will NOT be appointed for that semester.**

To be classified as an internship and to receive up to three elective credits (EGN 5949), the job duties of the internship must consist of engineering design. Positions not acceptable for graduate internship credit include undergraduate level work, technician, data entry, clerical work, part-time work, etc. Students must also complete a technical report in order to receive credit for their internship.

Students can count a maximum of 3 credits of EGN 5949 toward their degree program. Internship credits will count toward the independent study total of a student's degree program (i.e., Master's students can only count a maximum of 6 credits of EEL 5905, EEL 6905, and/or EGN 5949 toward their degree program).

Each student is required to generate a technical report (2000-word minimum, excluding graphs, equations, circuits, and/or computer code) to receive credit for their internship. The report must meet IEEE publication guidelines and include the following: title, author's name, abstract, introduction of the tasks carried out, methodology used, results, discussion, acknowledgements, and references. Confidential material should not be included, but students are expected to include technical details and assessments, equations, graphs, circuits, etc.

More information about the ECE Graduate Internship Program can be found in the Student Services Office.

## 9. Financial Aid

Applications for teaching assistantships, research assistantships and fellowships are available from the Department of Electrical and Computer Engineering. Fellowships are highly competitive and generally require completed applications by January each year. Recipients of teaching assistantships are selected by the Associate Chairman of the ECE department. Research assistantships are awarded by individual faculty members with funding from governmental or industrial sources and are generally awarded only to those students who have been in residence at least one semester.

The minimum stipend for students on appointment in the ECE department is \$21,400 for a 12-month appointment. Minimum stipends for other departments and assigned duties for teaching assistants are determined by the Graduate School and are in accordance with the assistantship appointment. Duties include grading, staff meetings, class preparation, student consultation, required lecture attendance, and research not directly related to the student's thesis or dissertation. Students will also have assigned classroom or laboratory teaching responsibilities. International students who wish to be eligible for graduate

assistantships must pass the SPEAK (TSE) or TOEFL iBT test. The passing score for the SPEAK test is 55. Students who score a 45 or 50 must take EAP 5836, Academic Spoken English, but are still allowed to hold a graduate assistantship. A passing score for the TOEFL iBT test is a 28. Students who score in the 23-27 range must enroll in EAP 5836 during your first semester of teaching. Students who score less than 23 on the TOEFL iBT will be required to take the SPEAK test to be considered for a TA position.

## 10. Tuition Waivers

Tuition waivers are awarded to graduate students who have been awarded an assistantship from 1/4 time - 1/2 time. Fee waivers are contingent on the availability of funds. Due to the limit of available funds, no fee waivers are available without assistantship appointments. The waivers are processed under strict guidelines provided by the Graduate School.

## 11. No Assistantships While on Internship

Due to intellectual property rights, it is the policy of the ECE department that students on an assistantship cannot keep their assistantship while on an internship. It is expected that a student with an assistantship fulfill the terms of that assistantship.

Students who hold appointments at UF must be cognizant of the start and end dates of their appointments while making internship plans. Students are not permitted to be on appointment and be on internship at the same time. Students on appointment are responsible for knowing the start and end dates of their appointment when negotiating the timeframe of their internship. Students who arrange internships that conflict with their UF appointment start and/or end dates will NOT be appointed for that semester. The assistantship will be terminated and the tuition waiver cancelled for students who leave for a paid internship after the semester has begun. The student will be liable for all fees covered by the tuition waiver at the appropriate rate.

Students returning from a paid internship after the semester has started will not be reappointed to the assistantship until the beginning of the following semester.

## 12. Readmission Procedures

Students who have left the program prior to graduating and wish to be readmitted, require the following:

- A minimum GPA of 3.00 for readmission into the Master's program and a minimum GPA of 3.5 for readmission to the Ph.D. program.
- GRE scores that satisfy the admission requirements of the ECE program in effect at the time of readmission.
- Three letters of recommendation from faculty members in the ECE department.

Readmission is not guaranteed, irrespective of the circumstances that necessitate it.

## VIII. Format of Ph.D. Oral Qualifying Exam Proposal

The written proposal should be submitted to the dissertation committee members no later than 15 days before the proposal defense.

The written proposal must outline the area of research and its importance, problem statement, background to the research area, specific tasks that will be performed, preliminary results, and subsequent steps. A number of excellent manuals (consult, for example, references available via [www.nsf.gov](http://www.nsf.gov)) are available on writing research proposals and may be used as guides in preparing the proposal. A maximum of 15 single-spaced, typed (10-point or larger font) pages, including figures and tables is allowed. It should include a title, a table of contents, references, and an abstract in addition to the 15 pages of text. A maximum of two appendices such as submitted papers, detailed derivations, etc. could be included in addition to the 15-page proposal. The main body of the text would typically consist of the following:

- Introduction: A concise overview of the research area and topic and their importance.
- Background: Literature review and relevant background needed to place the proposed study in the larger context and to highlight the relevance and the novelty of the proposed work.
- Problem description: A description of the specific problem and the objectives of the proposal and the novelty of the proposed work.
- Specific tasks: A description of proposed theoretical and/or experimental work and a list of specific tasks needed to accomplish the proposed objectives.
- Preliminary work: Description of any preliminary work performed by the student and an analysis or discussion of such preliminary work.
- Future tasks: Details of the subsequent steps planned to achieve the specific objectives of the research.
- Concluding remarks.
- References: A list of references cited in the proposal. List of references does not count toward 15-page limit.

Tables and figures used in the proposal should be integrated into the text.

## X. Graduate Course Descriptions

Course syllabi can be found at the Associate Chair's website (<http://www.associatechair.ece.ufl.edu/syllabi.html>). Syllabi not available on this website can be requested from the course instructor.

The latest graduate course descriptions are located in the online graduate catalog at <http://gradcatalog.ufl.edu/index.php?catoid=11>

XI. Graduate Research Division Flow Charts



# 1. Computer Engineering

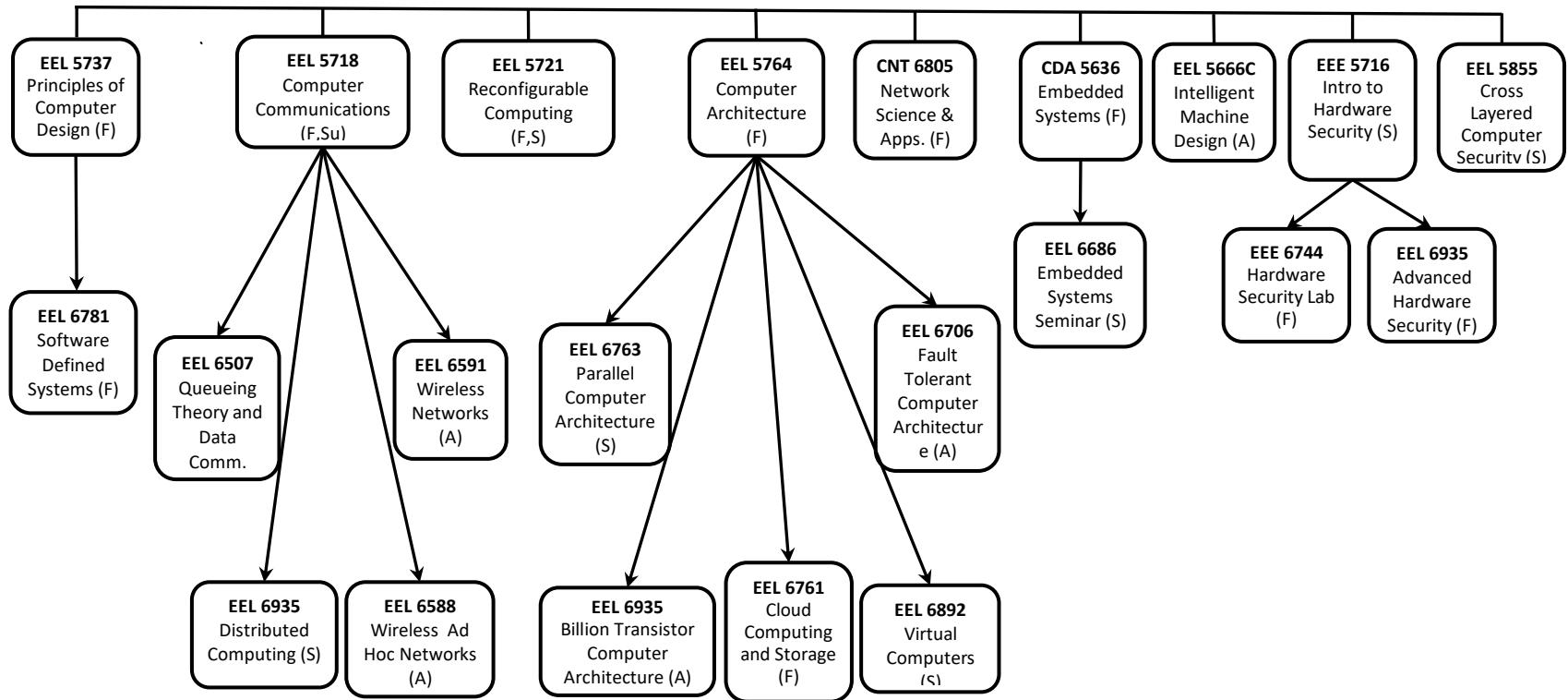

## Special Topics

### Key

- F = Fall
- S = Spring
- Su = Summer
- A = Aperiodic
- 2 = Every 2 years

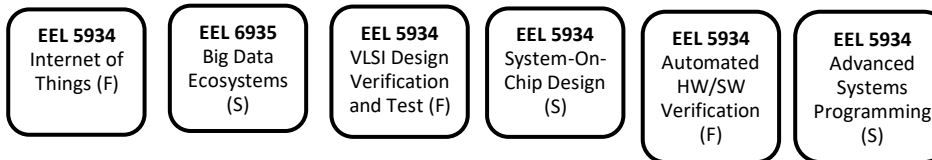

## 2. Devices

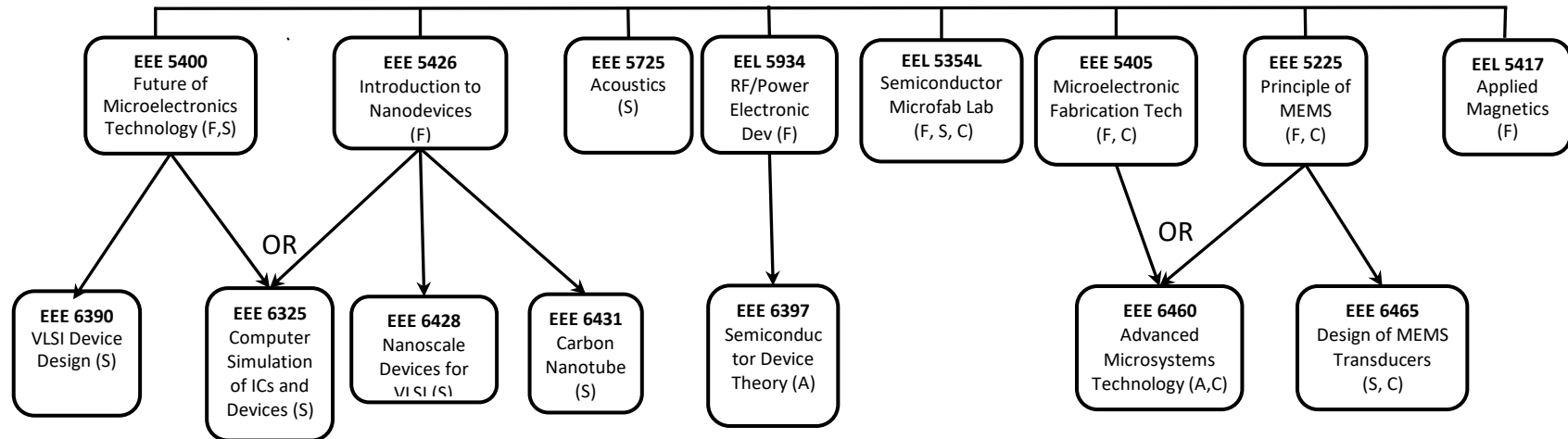

### Key

F = Fall  
 S = Spring  
 Su = Summer  
 A = Aperiodic  
 2 = Every 2 years  
 C = Certificate

### Special Topics

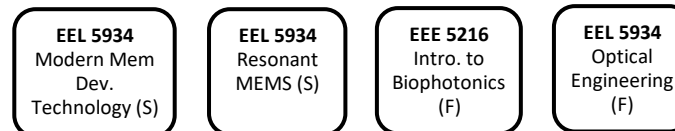

### 3. Electromagnetics & Energy Systems

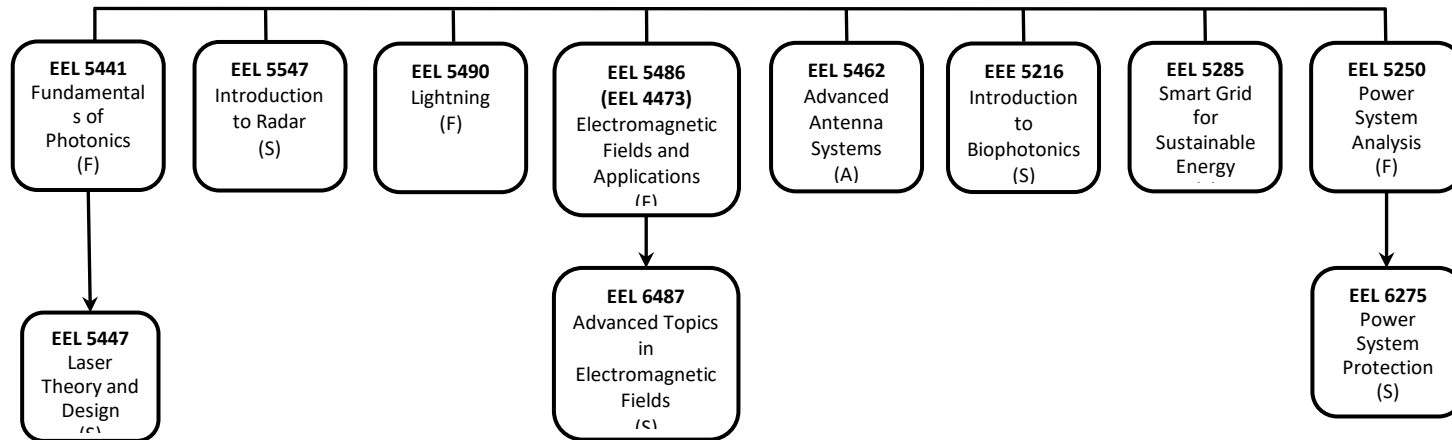

#### Special Topics

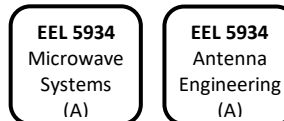

#### Key

F = Fall  
S = Spring  
Su = Summer  
A = Aperiodic  
2 = Every 2 years

#### Related Courses:

EEE 5426 Introduction to Nanodevices  
 EEE 6328C Microwave IC Design  
 EEE 6374 RF Circuits and Systems  
 EEE 6382 Semiconductor Physical Electronics  
 EEE 6397 Semiconductor Device Theory  
 EEE 6428 Computational Nanoelectronics  
 EEE 6431 Carbon Nanotubes  
 EEL 5451L Photonics Lab

### 4. Electronics

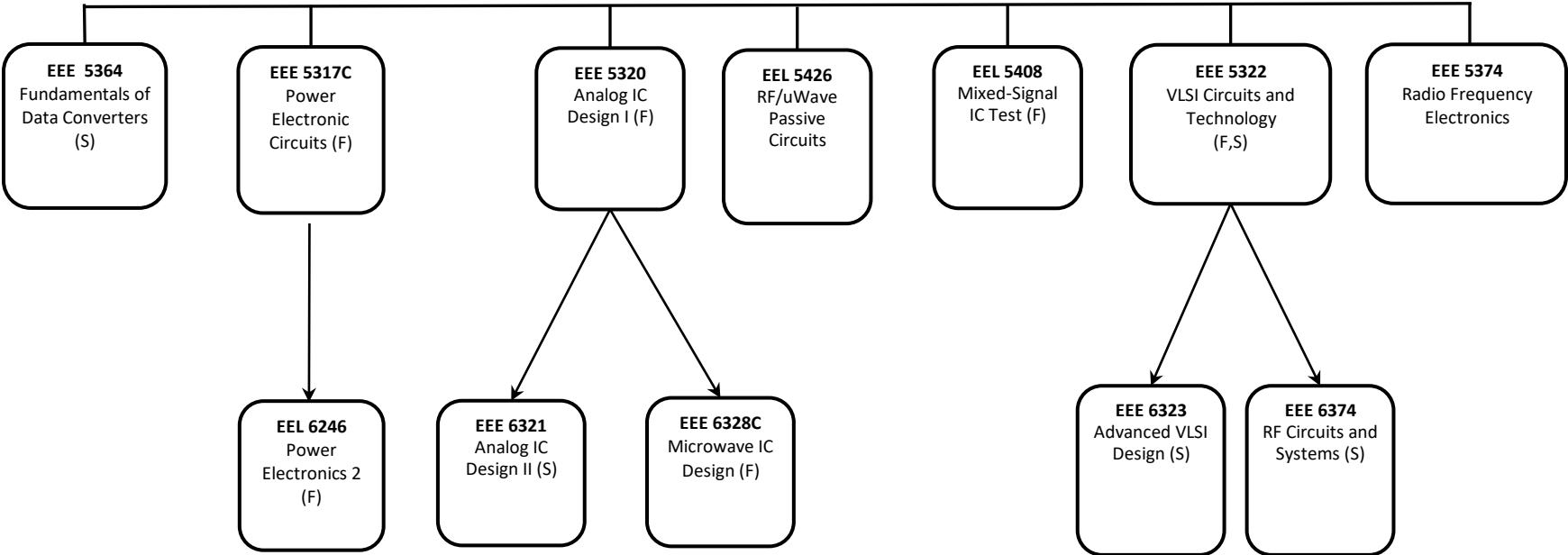

Key

- F = Fall
- S = Spring
- Su = Summer
- A = Aperiodic
- 2 = Every 2 years

Special Topics



## 5. Signals & Systems

